

# SPECIFICATION FOR APPROVAL

# 承 认 书

CUSTOMER

NUMBER

客户名称:

编 号:

DESCRIPTION

QUANTITY

品 名: 贴片共模滤波器

数 量:

PART NO.

DATE

型 号: BCDM5040-SERIES

日 期:

CUSTOMER PART NO.

NOTE

客户料号:

注 解:

APPROVAL SIGNATURE  
客户承认签章

APPROVED BY 核 准	Q. C. DEPT. 品 管	CHECKED BY 核 查	DRAWN BY 制 作

深圳市宝创达电子有限公司

SHENZHEN BAOCHUANGDA ELECTRONICS CO., LTD.

地址: 深圳市宝安区石岩街道罗租社区黄峰岭工业大道江峡科技园F栋201

Add: 201, Building F, Jiangxia Science and Technology Park, Huangfengling Industrial Avenue, Luozhu Community, Shiyan Street, Bao'an District, Shenzhen

Tel: 0755-29736760 Fax: 0755-28056434

Http:// www.bcdcn.com

# BCDM5040-SERIES

## SMD COMMON MODE FILTER

SHAPES AND DIMENSIONS/CIRCUIT DIAGRAM/RECOMMENDED

PC BOARD PATTERN(REFLOW SOLDERING)

◆ Dimensions (mm)

BCDM5040-191T~302T

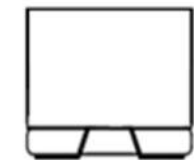
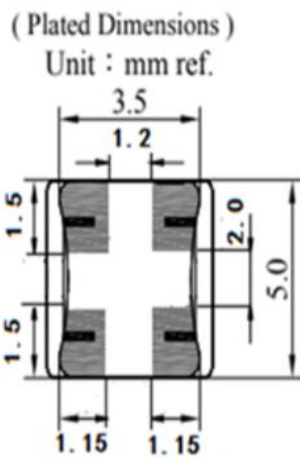
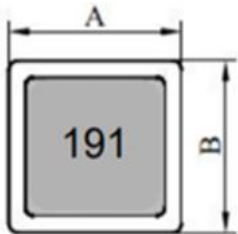

BCDM5040-402T

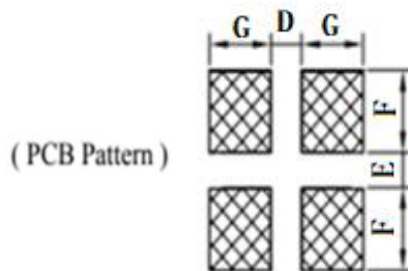
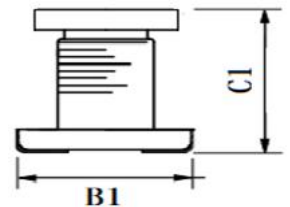
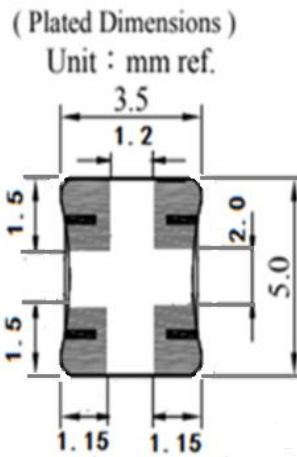
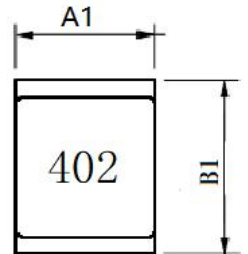

A	B	C	A1	B1	C1	D	E	F	G
5.0±0.3	5.0±0.3	4.5 max	3.5±0.3	5.0±0.3	4.4 max	0.8 ref	1.0 ref	2.3 ref	1.6 ref

◆ Schematics(Bottom)

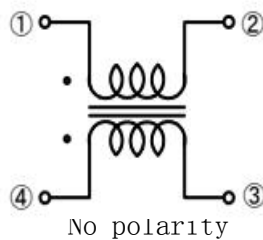

# BCDM5040-SERIES

## SMD COMMON MODE FILTER

### DESCRIPTION:

- a . Ferrite drum core construction
- b . Magnetically shielded
- c . Enamelled copper wire: H class
- d . Product weight: 0.30g (ref.)
- e . Moisture sensitivity Level 1
- f . Products comply with RoHS' requirements
- g . Halogen free

### GENERAL SPECIFICATION:

- a . Storage temp. : -40°C ----+125°C
- b . Operating temp. : -40°C ----+125°C  
(Temp. rise included)
- c . Resistance to solder heat:  
260°C.10 secs.

Peak Temp: 260°C max  
 Max. Peak Temp - 5°C: 30sec max  
 Max time above 217°C :  
 60sec~150sec max.

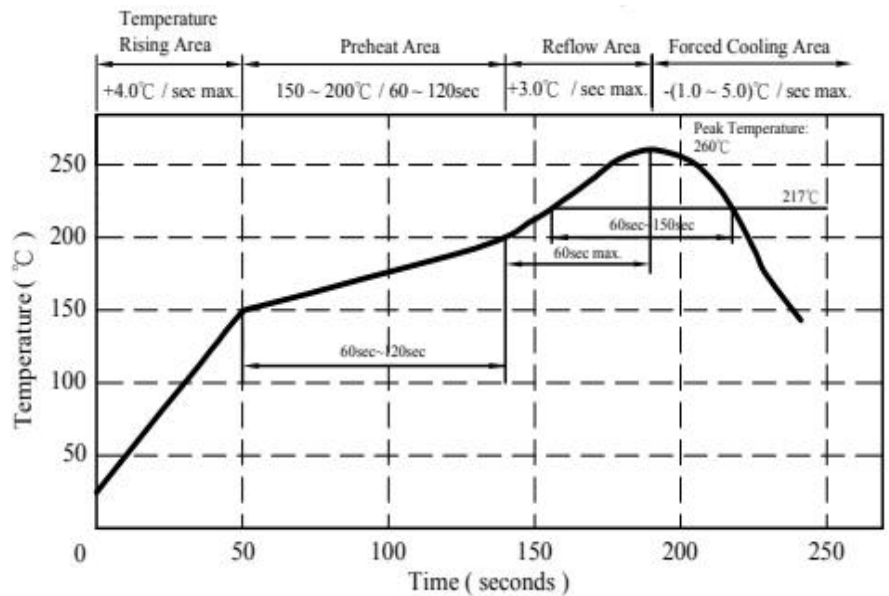

### ELECTRICAL CHARACTERISTICS:

DWG. No.	Common mode impedance (at 100MHz) ( $\Omega$ typ)	RDC (max.) (m $\Omega$ )	IDC (A)	Rated voltage(dc) (V)	Withstand Voltage (dc) (V)
BCDM5040-191T	190	20	5	50	125
BCDM5040-351T	350	40	2	50	125
BCDM5040-501T	500	50	1.8	50	125
BCDM5040-102T	1000	60	1.5	50	125
BCDM5040-152T	1500	100	1	50	125
BCDM5040-302T	3000	200	0.5	50	125
BCDM5040-402T	4000	300	0.2	50	125

- (1). Electrical specifications at 25°C
- (2). Insulation Resistance 10M $\Omega$  min.
- (3). IDC base on Temp. rise 40°C typ.

# BCDM5040-SERIES SMD COMMON MODE FILTER

## TYPICAL ELECTRICAL CHARACTERISTICS

BCDM5040-191T

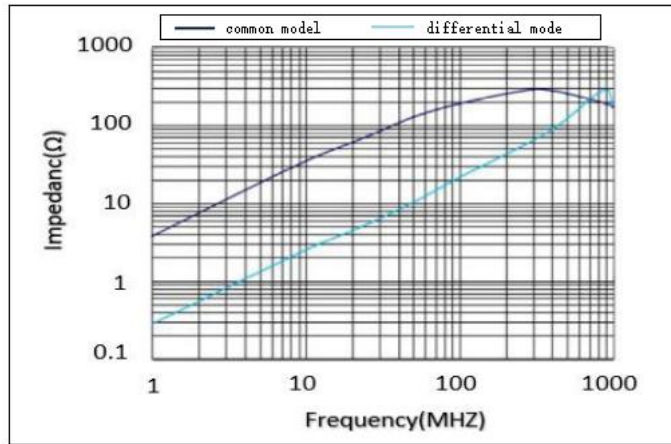

BCDM5040-351T

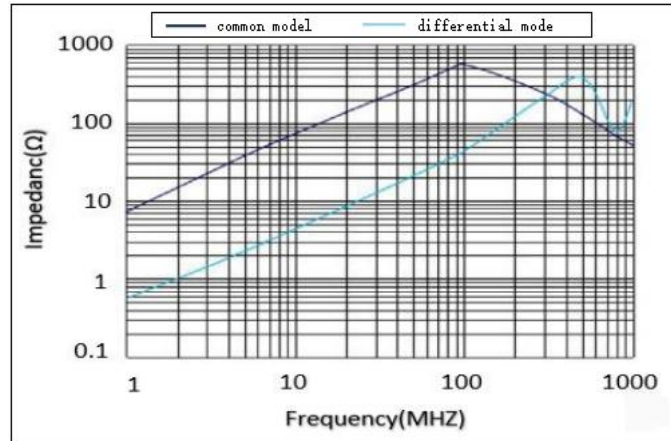

BCDM5040-501T

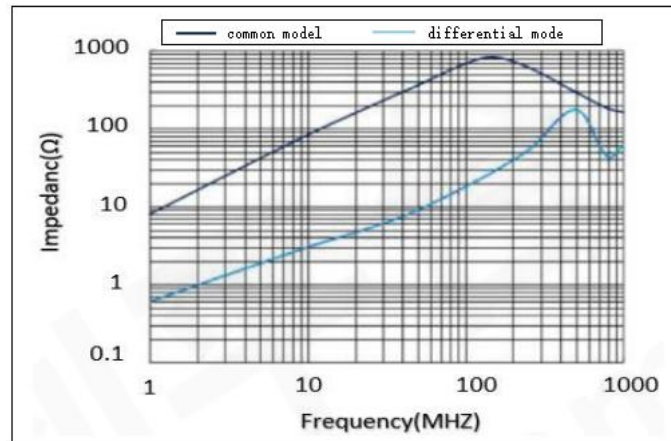

# BCDM5040-SERIES SMD COMMON MODE FILTER

## TYPICAL ELECTRICAL CHARACTERISTICS

BCDM5040-102T

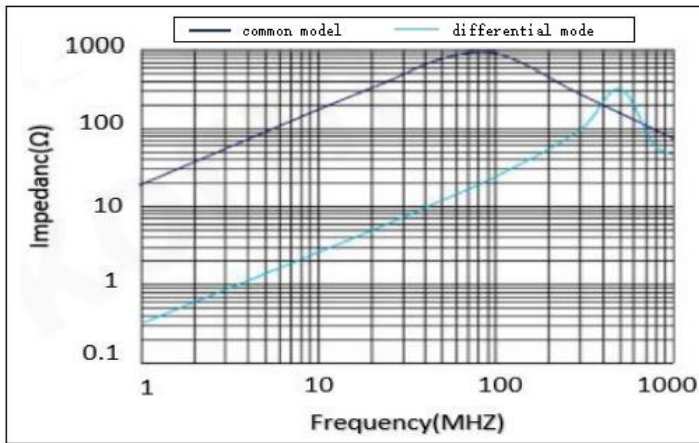

BCDM5040-152T

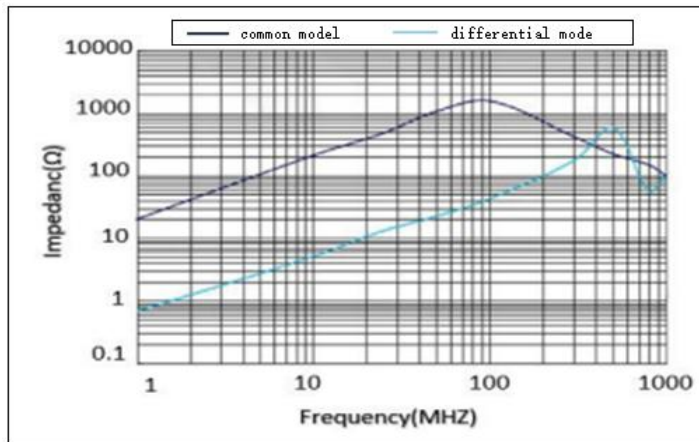

BCDM5040-302T

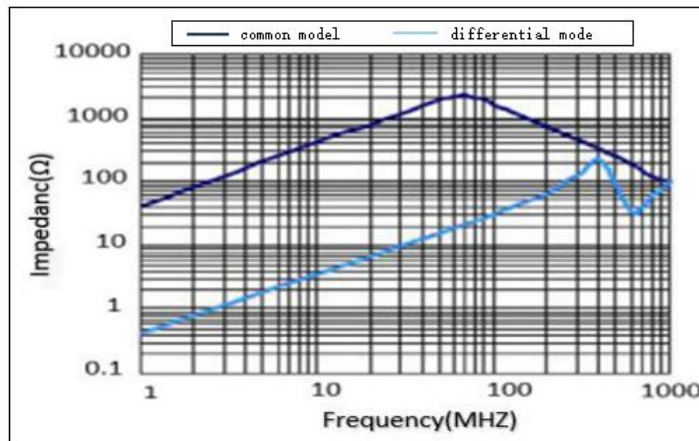

BCDM5040-402T

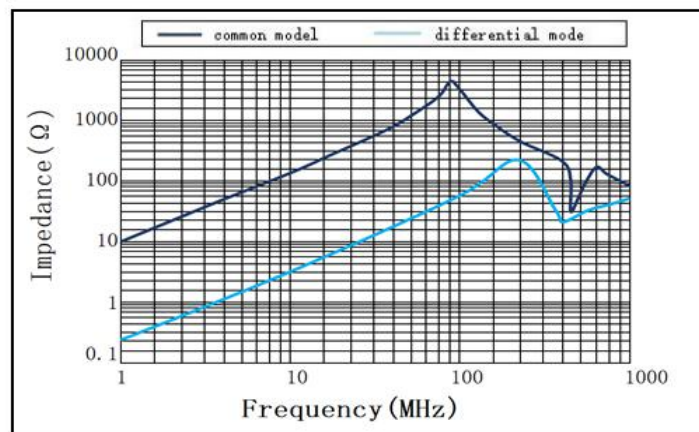

# BCDM5040-SERIES

## SMD COMMON MODE FILTER

### PACKAGING INFORMATION:

#### ( 1 ) Configuration

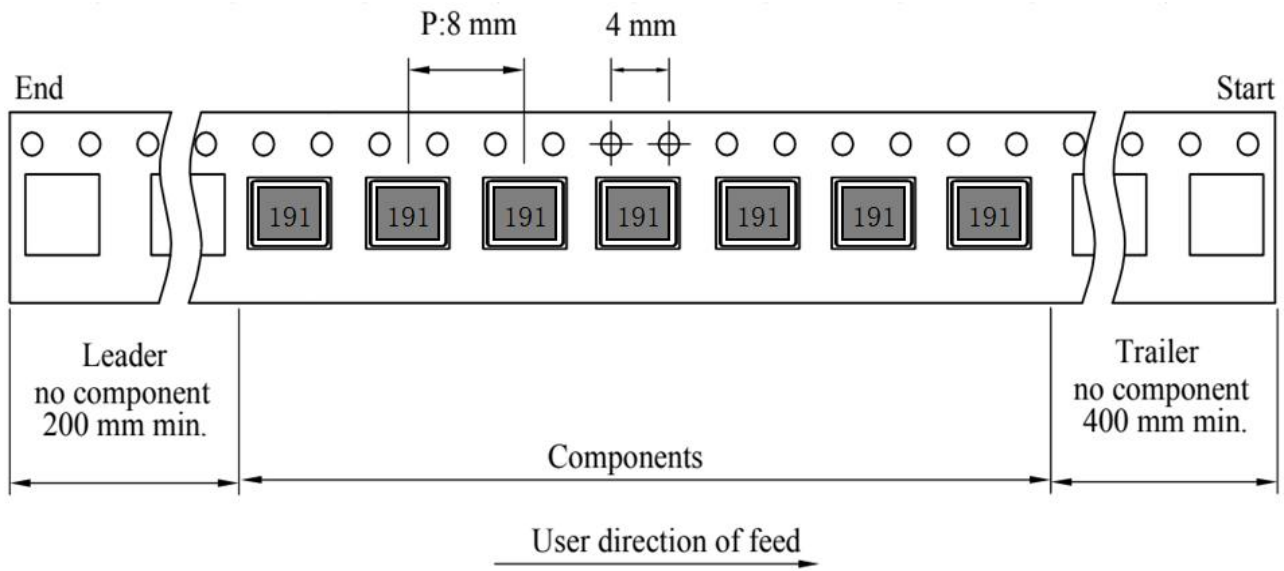
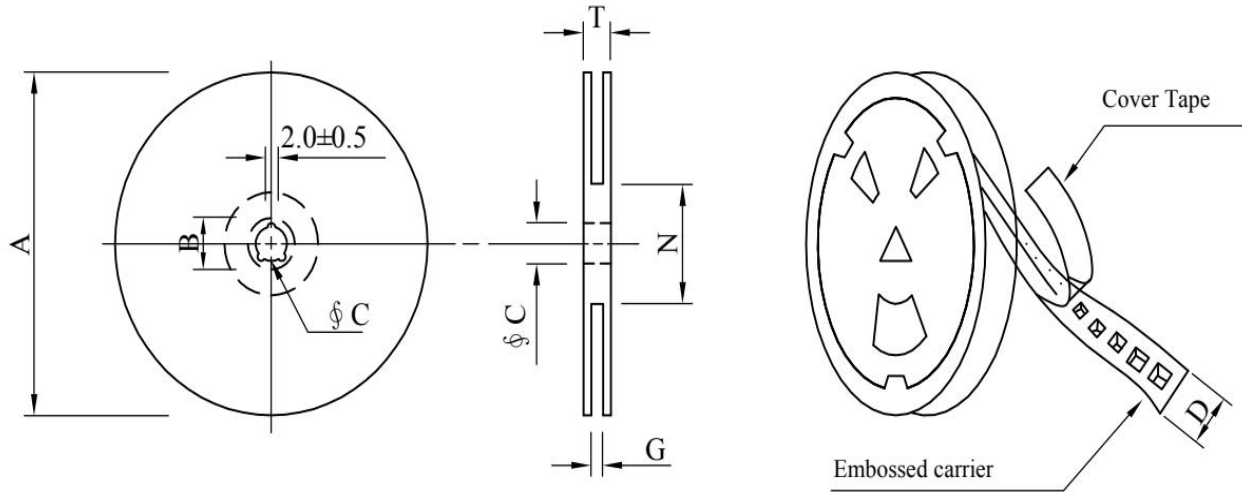

#### ( 2 ) Dimensions

Unit:mm

Style	A	B	C	D	G	N	T
13-12	330	21±0.8	13±0.5	12	14+0	50-0	18.4

#### ( 3 ) Q'TY & G.W. Per package

Code	Inner:Reel			Outer:Carton		
	QTY(pcs)	G.W. (g)	Style	QTY(pcs)	G.W. (kg)	Size (cm)
B	1000	400	13-12	8000	3.5	36×36×16

# BCDM5040–SERIES

## SMD COMMON MODE FILTER

### RELIABILITY TEST:

Item	Reference document	Test Condition	Test Specification
1.High Temperature Exposure	MIL-STD-202 Method 108	1.Temperature:125±2°C 2.Time:96±2 hours.	1.No mechanical or electrical damage. 2.Impedance shall not change more than ±50%.
2.Temperature Cycling	JESD22-A 104	1.Temperature: -40°C ~+125°C 2.Number of cycle:100 cycles 3.Dwell time:30 minutes	1.No mechanical or electrical damage. 2.Impedance shall not change more than ±50%.
3.Biased Humidity Test	MIL-STD-202 Method 103	1.Temperature : 85±2 °C 2.Humidity: 85% RH. 3.Time:96±2 Hours	1.No mechanical or electrical damage. more than ±50%.
4.Operational Life	JESD22-A 108	1.Temperature: (Temp. rise included) 2.Time:96±2 hours. 3.Rated current	1.No mechanical or electrical damage. 2.Impedance shall not change more than ±50%.
5.External Visua	JESD22-B 101 & MIL-STD-883 Method 2009	Inspect product constructions, marking and workmanship.	1.No pollution on the surface of 2.Clear marking. 3.No crac
6.Physical Dimensions	JESD22-B 100	Verify physical dimensions to the applicable product detail specification.	Per product specification standard
7.Resistance to solvents	MIL-STD-202 Method 215	Immerse into solvent for 3±0.5 minutes & brush 10 times for 3 cycles.	1.No body change in apperance. 2.No marking blurred. 3.Impedance shall not change more than ±50%.
8.Vibration Test	MIL-STD-202 Method 204	1.Frequency and Amplitued : 10-2000-10 Hz, 1.5 mm. 2.Direction:X, Y, Z 3.Test duration:2 hours for each direction , 6 hours in total.	1.No mechanical or electrical damage. 2.Impedance shall not change more than ±50%.
9.Resistance To Soldering Heat Test	MIL-STD-202 Method 210 & J-STD020D.1	1.Highest temperature : 260±5 . °C 2.Time ( temp.≥ 217°C ) : 60~150 Seconds. 3.IR reflow times : 3 times.	1.No mechanical or electrical damage. 2.Impedance shall not change more than ±50%.
10.Over load	JIS C 6436 & User SPEC.	1.Applied one and half rated current for a period of 5 minutes. 2.Rated current	No electrical or mechanical damage
11.Temperature Rise	JIS C 6436 & User SPEC.	1.Applied rated current for 10 minutes. 2.Temperature measure by digital thermometer. 3.Irms current	Surface temperature rise is less than 40°C typ
12.Solderability Test	J-STD-002 & JESD22-B 102	1.Baking in pre-testing : 150±5°C / 16Hours±30 min. 2.Peak temperature : 240±5°C 3.Time ( temp.≥217°C ) : 60~150 4.IR reflow times : 1 time.	More than 95% soldering coverage min on terminations.
13.Electrical Characteriazation	MIL-STD-202 Method 304 & User SPEC.	1.Operating temperature : -40°C~125 °C 2.Room temperature : 25°C.	1.No mechanical or electrical 2.Impedance shall not change more than ±50%.
14.Withstanding Voltage Test	MIL-STD-202 Method 301 & User SPEC.	1.DC: V (Winding to Winding) 2.Time : 1minutes	1.During the test no breakdown. 2.No mechanical or electrical
15.Drop	CNS-C6354 & GB/T 2423.8	1.Products shall be mounted on SPEC. and dropped down from a height of 2.Drop total time : 6 times (Every side of sample drop 2 time)	1. Adhesion on PCB shall be enough 2. Product appearance shall not break. 3. No electrical damage.
16.Terminal Test	IEC 60068-2-21	1.Apply push force to samples mounted on PCB. 2.Force of 1.8 kg for 60±1 seconds.	After test, inductors shall be no mechanical damage