

SPECIFICATION FOR APPROVAL

承 认 书

CUSTOMER

客户名称:

DESCRIPTION

品 名: 共模滤波器

PART NO.

型 号: BCDT1806-2-302B

CUSTOMER PART NO.

客户料号:

APPROVAL SIGNATURE 客户承认签章

APPROVED BY 核 准	Q. C. DEPT. 品 管	CHECKED BY 核 查	DRAWN BY 制 作

深圳市宝创达电子有限公司

SHENZHEN BAOCHUANGDA ELECTRONICS CO., LTD.

地址: 深圳市龙华区观澜街道横坑河西村77号A栋2楼

Add: 2nd floor building A no.77 hexi village guanlan
Street longhua district shenzhen

Tel: 0755-29736760 Fax: 0755-28056434

Http:// www.bcdcn.com

BCDT1806-2-302B

DC COMMON MODE FILTER

FEATURES

- A common mode filter for large current applications.
Common mode impedance surpasses 900 Ω at 13MHz-50MHz.
Noise is greatly suppressed.
- Capable of handling the highest current (up to 10A) of any common mode filter.
- Height and size have been considered, resulting in a compact and light-weight choke coil. Applicable for the miniaturization required to reduce the size and weight of portable equipment.
- The products contain no lead and also support lead-free soldering.
- The product does not contain regulated substances that are slated to be included in ROHS.

APPLICATIONS

Used for power line noise suppression for any electronic devices
Used to counter adapter/battery line noise for relatively large electronic devices such as notebook PCs, stand-alone word processors, etc

TEMPERATURE RANGES

Operating	-40to+100°C
Storage (After mount)	-40to+100°C

Part Number System

BCDT 1806 -2 -302 B

① ② ③ ④ ⑤

- ① Type:BCDT
- ② Core External Dimensions (mm):18*6
- ③ Number of Lines: 2
- ④ Impedance:302=3000 Ω
- ⑤ Packing: Bulking

ELECTRICAL CHARACTERISTICS

Part No.	Impedance		DC resistance	Rated current	Insulation resistance
	(Ω) typ [at 30MHz]	(Ω) min [at 13MHz - 50MHz]	(m Ω) max [1 line]	I _{dc} (A) max	(M Ω) min
BCDT1806-2-302B	3000	900	9.5	10	10

1/3

BCDT1806-2-302B

DC COMMON MODE FILTER

TYPICAL ELECTRICAL CHARACTERISTICS

IMPEDANCE vs. FREQUENCY CHARACTERISTICS

BCDT1806-2-302B

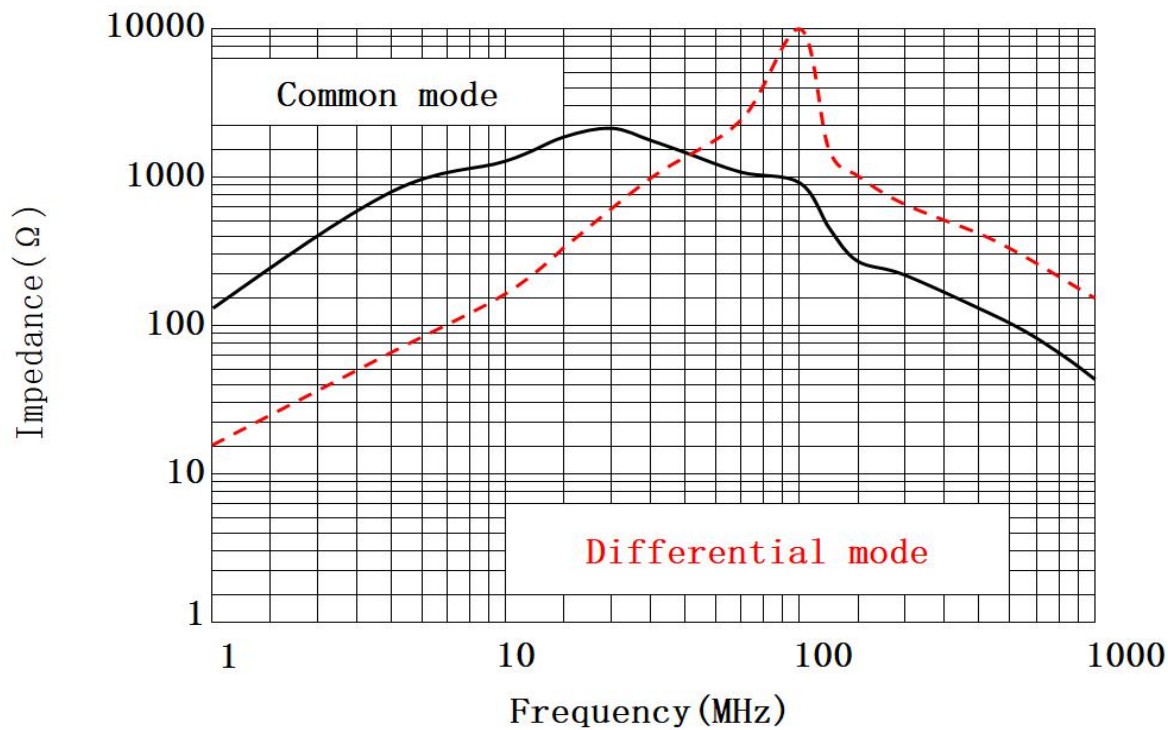

DC COMMON MODE FILTER

SHAPES AND DIMENSIONS/CIRCUIT DIAGRAM

◆ Dimensions(mm)

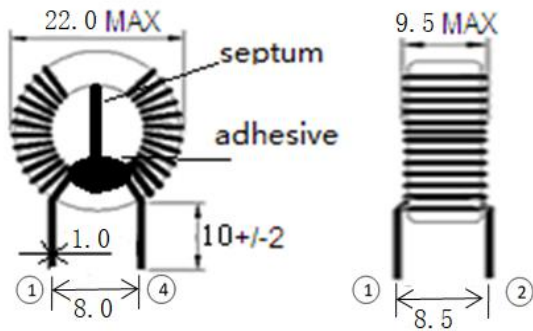

Schematics (Bottom)

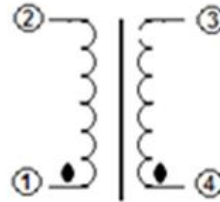

No polarity

GENERAL CHARACTERISTICS

1. STORAGE TEMPERATURE RANGE : $-40^{\circ}\text{C} \sim +100^{\circ}\text{C}$
2. OPERATING TEMPERATURE RANGE : $-40^{\circ}\text{C} \sim +100^{\circ}\text{C}$ (INCLUDING SELF TEMPERATURE RISE)
3. EXTERNAL APPEARANCE : NO EXTERNAL DEFECTS CAN BE FOUND IN THE VISUAL INSPECTION.
4. TERMINAL STRENGTH : NO DISTINGUISHED TERMINAL PEELING OFF OR WIRE BROKEN SHOULD BE FOUND AFTER EACH OF THE TERMINAL IS APPLIED WITH STATIC PULLING FORCE OF 8N FOR 60 ± 5 SECONDS.
5. HEAT RESISTANCE : NO DISTINGUISHED STRUCTURE AND ELECTRIC DEFECTS SHOULD BE FOUND AFTER $1.5 \pm 0.5\text{mm}$ HIGH BOTTOM OF ALL THE TERMINALS ARE IMMERSDED IN THE MELTED SOLDER OF $270 \pm 5^{\circ}\text{C}$ FOR 5 ± 1 SECONDS.